



GUARDRAILS

www.fw-nicol.com

Singapore • Philippines • Bangladesh • Sri Lanka

HIGHWAY GUARDRAIL PRODUCT FEATURES & APPLICATION

- * To Provide Railing Protection To Motor Vehicle At Dangerous Road Area Such As
 - Steep Slope
 - High Embankment
 - Obscure Curve/Bend
 - Sharp Corner
- * To Absorb Sudden Impact During Collision Thus Minimise Injury To Vehicle And Passenger.
- * To Act As A Directional Railing For Vehicle Moving In The Right Direction.
- * To Act As A Median Barrier For Avoiding Head On Collision.
- * To Act As A Protective Barrier For Pedestrian Along The High Way.

SPECIFICATION AND TECHNICAL DATA

1. Base Metal specification to AASHTO M 180-89
 - Minimum Yield Strength : 345 N/mm²
 - Minimum Tensile Strength : 483 N/mm²
 - Minimum Elongation : 15%
2. Galvanising specification comply to AASHTO M 180-89
 - 1100g/m² minimum single spot test (for both sides)
 - 1220g/m² triple spot test (for both sides)
3. Dimension according to AASHTO M 180-89

TYPE	EFFECTIVE LENGTH (mm)	OVERALL LENGTH (mm)	NOMINAL UNCOATED THICKNESS (mm)
NGR 1	3810	4128	2.67
NGR 2	4000	4318	2.67
NGR 3	3810	4128	3.00
NGR 4	4000	4318	3.00

SECTION THROUGH BEAM

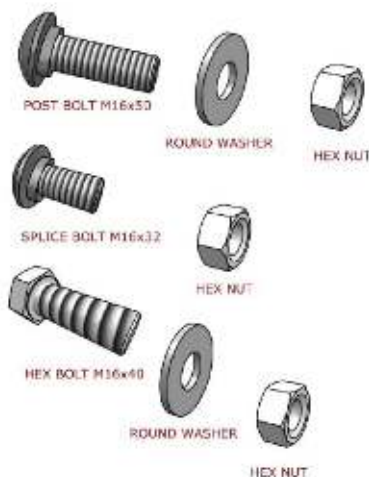
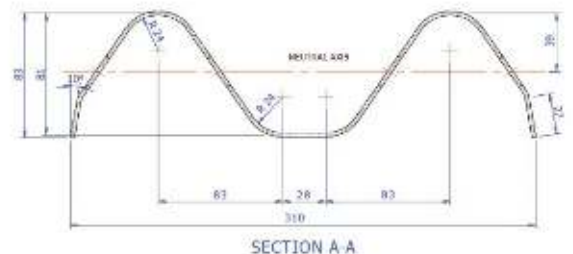
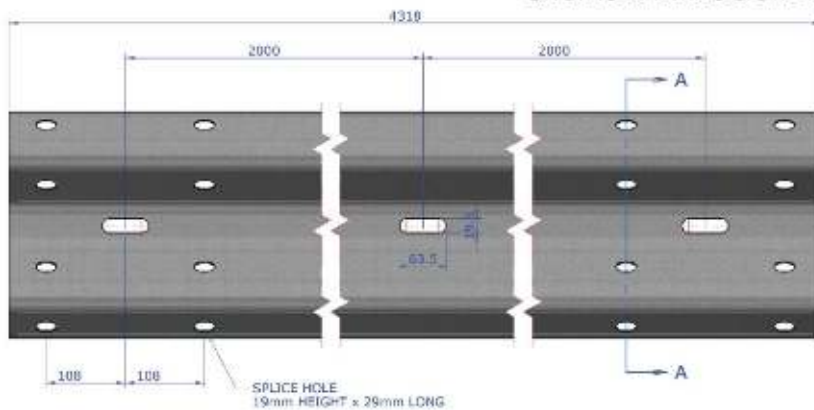

SPLICE BOLT & NUT

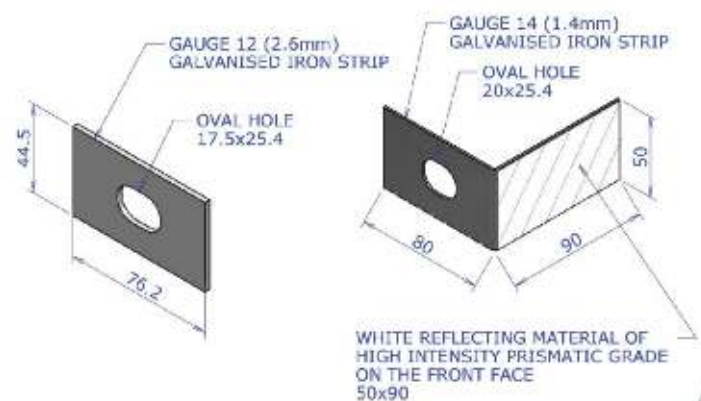

DELINEATOR STRIP

NOTE : All dimension are subject to manufacturer's design tolerance.
All dimension are in millimetre.

NICOL GUARD RAIL POST

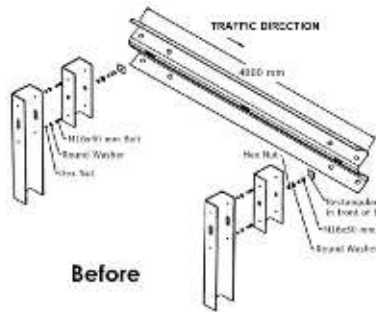
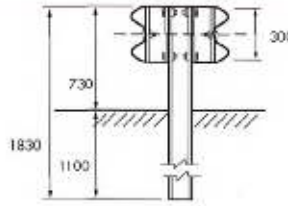
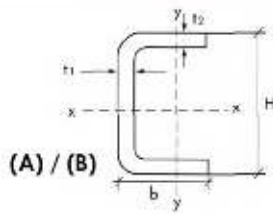

Before

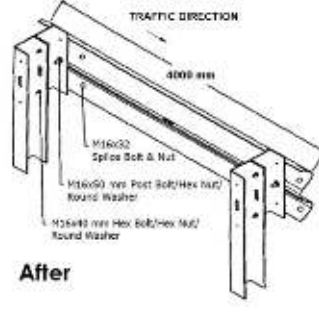

After



TYPE	H x b x t1 x t2 (mm)	Unit Weight (kg/m)
A	C178 x 76 x 6	14.3
B	C150 x 76 x 6	13.4

Total length : 1830 mm, subject to customer request.

TERMINAL UNIT (TYPE 1)

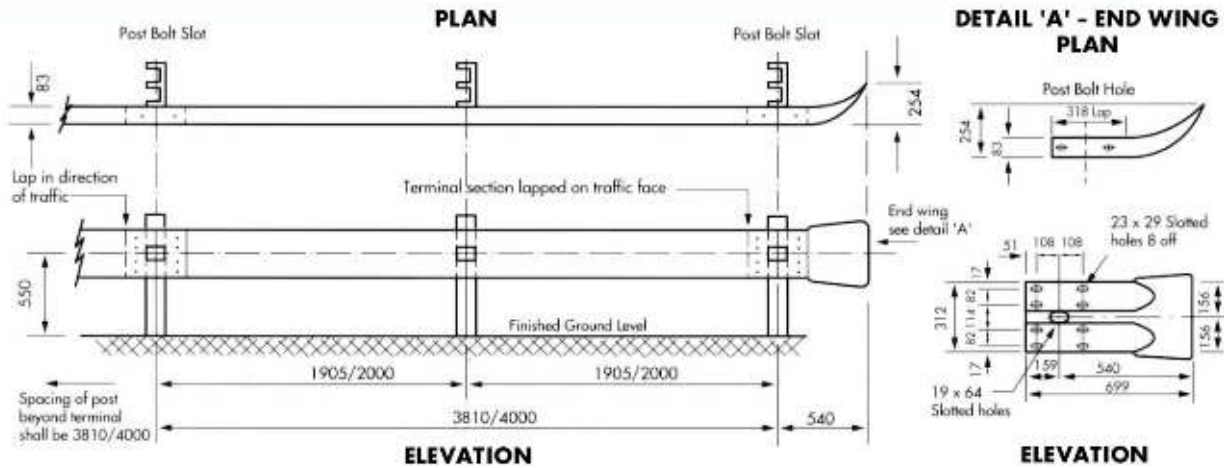

TERMINAL ANCHORAGE UNIT OR FLARE END (TYPE 2)

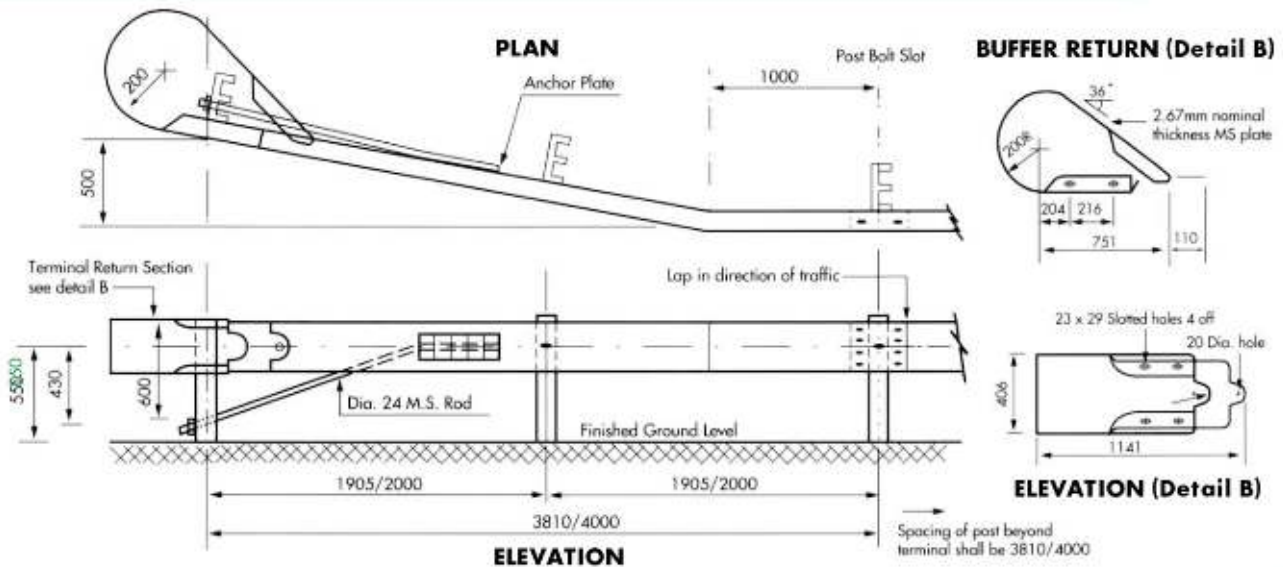

90° TWIST TERMINAL ANCHORAGE UNIT (TYPE 3)

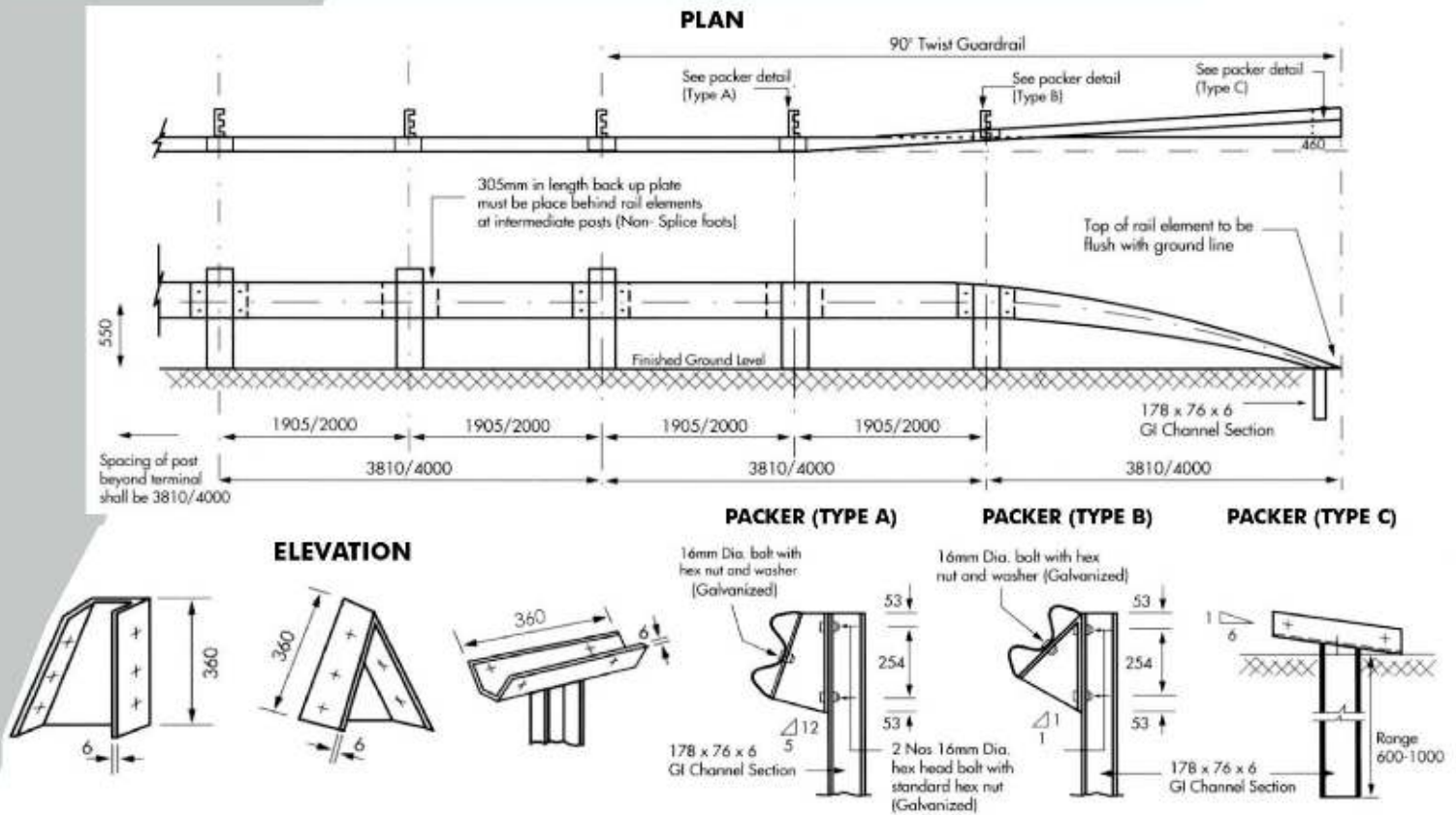

TERMINAL SECTION 1:6 (TYPE 4)

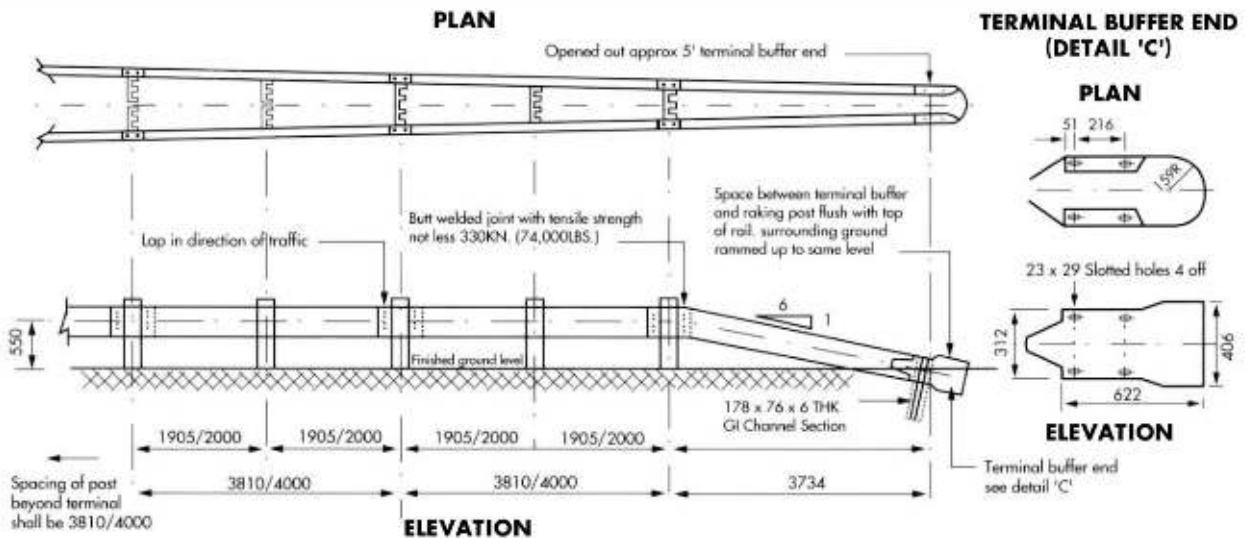

www.fw-nicol.com

NICOL
RELIABLE AFFORDABLE

FW NICOL INTERNATIONAL PTE LTD
28 Sin Ming Lane, Unit 05-139,
Midview City, Singapore 573972
Tel: +65 6884 0880
Email: singapore@fw-nicol.com

FW NICOL PHILIPPINES, INC.
1, San Miguel Ave, Unit 1601,
Ortigas Center, Pasig City, Philippines
Tel: +63 2 8632 9968
Email: philippines@fw-nicol.com

FW NICOL BANGLADESH LTD
UTC Building, 19th Floor, 8, Panthapath,
Kawranbazar, Dhaka 1215, Bangladesh
Tel: +880 96 1188 6779
Email: bangladesh@fw-nicol.com

FW NICOL LANKA (PVT) LTD.
No. 404/1, 1/1, Thimbrigasyaya Road
Colombo-05, Sri Lanka
Tel: +94 11 7202266
Email: srilanka@fw-nicol.com

FW NICOL CONSTRUCTION CORPORATION
1, San Miguel Ave, Unit 1601,
Ortigas Center, Pasig City, Philippines
Tel: +63 2 8632 9968
Email: construction@fw-nicol.com